

RoHS  Lead-free

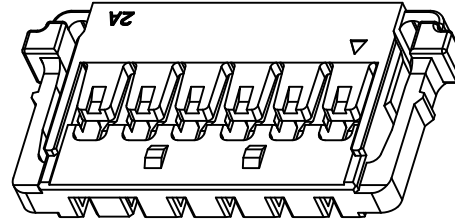

■ Specifications :

- Voltage rating: 150V AC / DC
- Current rating: 3A AC / DC
- Withstanding voltage: 500V AC/minute
- Temperature range: -25°C~+85°C
- Insulation resistance: ≥1000MΩ
- Contact resistance: ≤20mΩ
- After environmental testing: ≤40mΩ

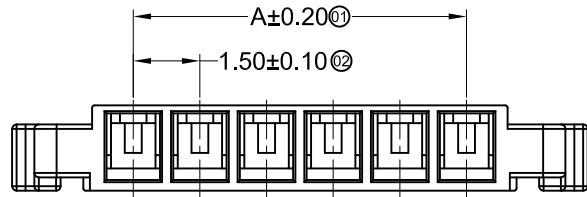
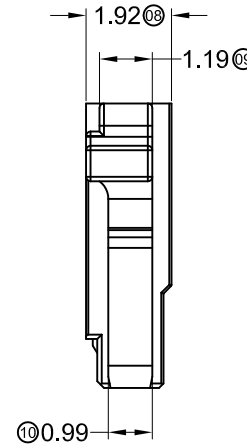
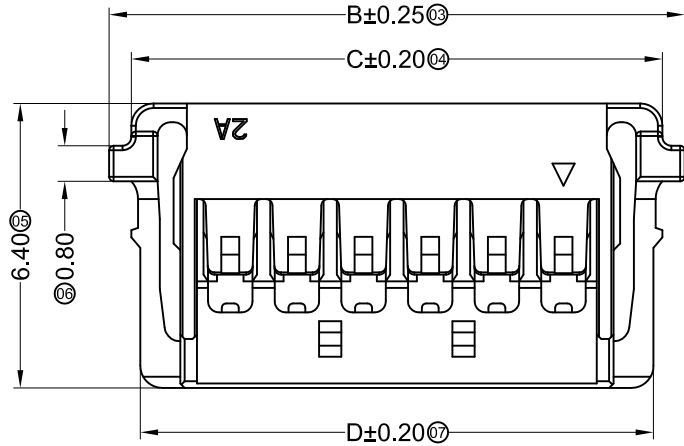

Poles	Dimensions(mm)			
	A	B	C	D
02	3.00	6.95	5.95	5.55
03	4.50	8.45	7.45	7.05
04	6.00	9.95	8.95	8.55
05	7.50	11.45	10.45	10.05
06	9.00	12.95	11.95	11.55
07	10.50	14.45	13.45	13.05
08	12.00	15.95	14.95	14.55
09	13.50	17.45	16.45	16.05
10	15.00	18.95	17.95	17.55
12	16.50	21.95	20.95	20.55

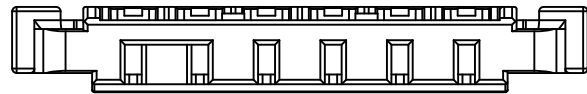

M1503H-XX	PA66 UL 94V-0	1503T	1503W
PART NO	Material	Suitable HLB Terminal	Mates With HLB Wafer

				GENERAL TOLERANCE				东莞市翰皓精密电子有限公司				PART NO. M1503H-XX			
				.X ±0.30				DONGGUAN HANHAO PRECISION ELECTRONIC CO.,LTD				TITLE 1.50 mm Crimp Style Connectors			
				.XX ±0.20				APPROVAL		CHECK		DRAWN		DATA	
				.XXX ±0.10								sylvia		2015/05/26	
DATE	OLD REV	NEW REV	ECN	DESCRIPTION	CHECK	APPROVAL	PROJECT					UNIT MM	SCALE 1:1	NUMBER A-000	REV A

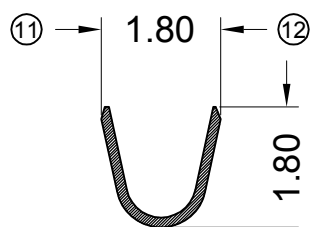
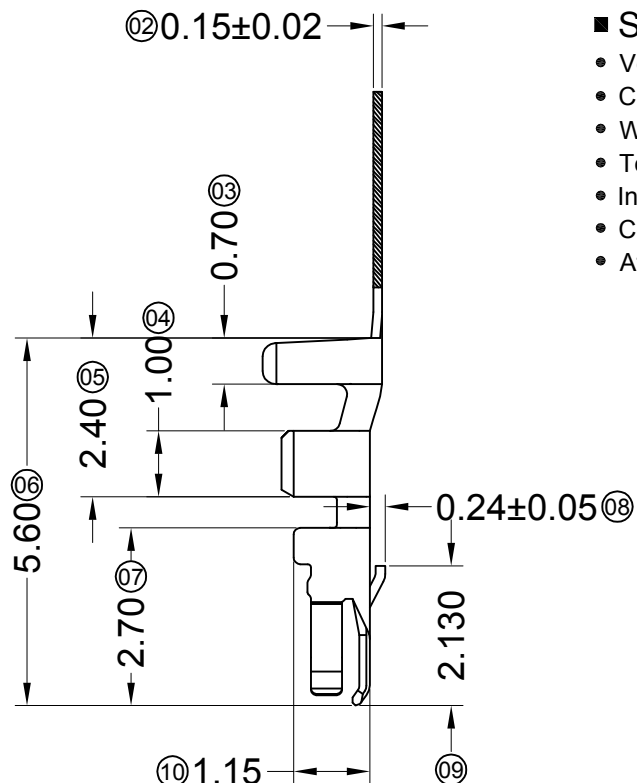
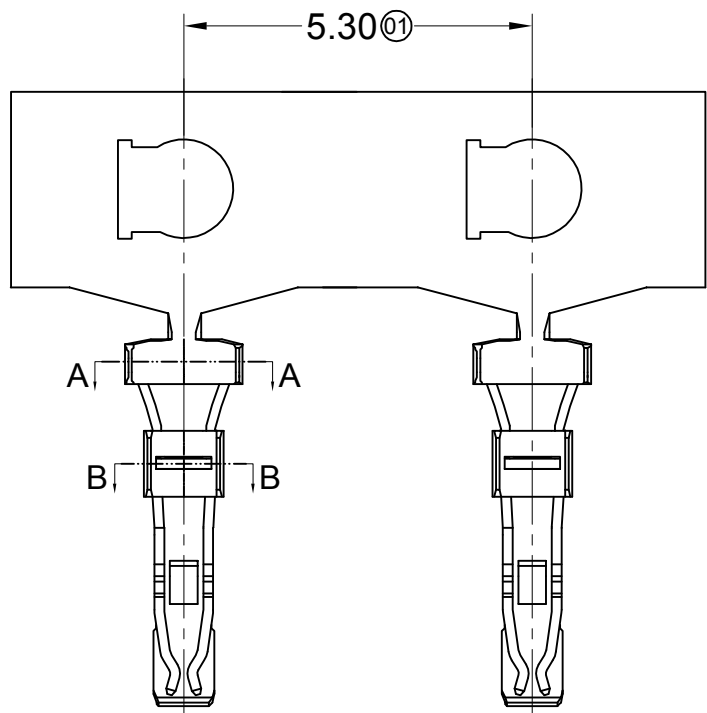

SECTION: A-A
SCALE: 1:1

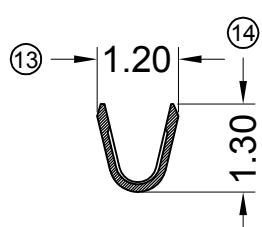

SECTION: B-B
SCALE: 1:1

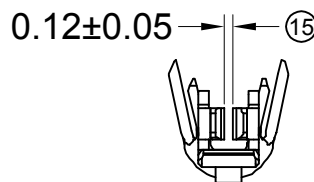

■ Specifications(规格):

- Voltage rating(额定电压): 150V AC / DC
- Current rating(额定电流): 3A AC / DC
- Withstanding voltage(耐压值): 500V AC/minute
- Temperature range(工作温度): -25°C~+85°C
- Insulation resistance(绝缘电阻): ≥1000MΩ
- Contact resistance(接触电阻): ≤20mΩ
- After environmental testing(环境测试后): ≤40mΩ

M1503TG	Phosphor Bronze	AWG#24-28	1.10mm(Max)	Stamping Before Plating:30u" Ni;70u"Sn Min.	1503H
PART NO	Material	Wire Range	Insulation O.D.	Finish	Used In HLB Housing

				一般公差 GENERAL TOLERANCE .X ±0.20 .XX ±0.15 .XXX ±0.08				东莞市翰皓精密电子有限公司 DONGGUAN HANHAO PRECISION ELECTRONIC CO.,LTD				料号 PART NO. M1503TG			
				核准 APPD 审核 CHK 绘图 DR 日期 DATA				品名 TITLE 1.50mm Crimp Style Connectors							
日期 DATE	旧版次 OLD REV	新版次 NEW REV	变更通知单 ECN	变更内容 DESCRIPTION	审核 CHK	核准 APPD	角法 PROJECT	核准 APPD	审核 CHK	绘图 DR	日期 DATA	单位 UNIT	比例 SCALE	图号 NUMBER	版次 REV
1			2	3	4	4				sylvia	2015/05/26	MM	1:1	A-014	A

RoHS

本产品符合我司QA-3-04-005
环境管理物质标准规范

工程图

■ 规格:

- 额定电压: 150V AC / DC
- 额定电流: 3A AC / DC
- 耐压值: 500V AC/minute
- 工作温度: -25°C~+85°C
- 绝缘电阻: ≥1000MΩ
- 接触电阻: ≤20mΩ
- 环境测试后: ≤40mΩ

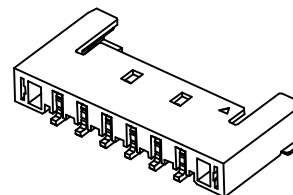
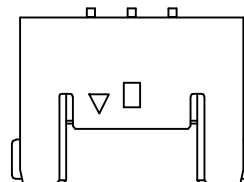
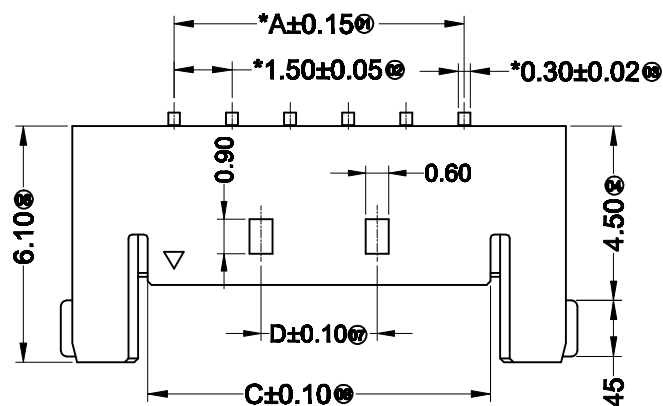

02P-04P Single Hole
Scale 1:0.7

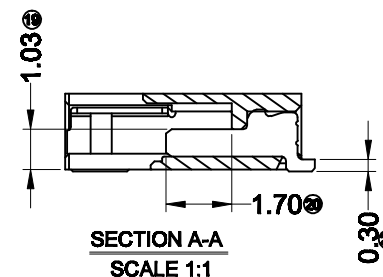
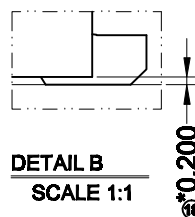
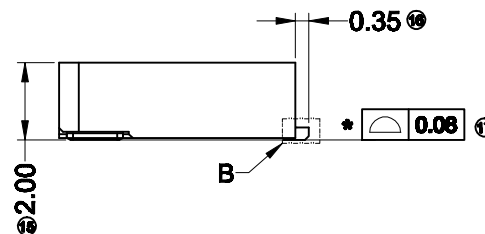
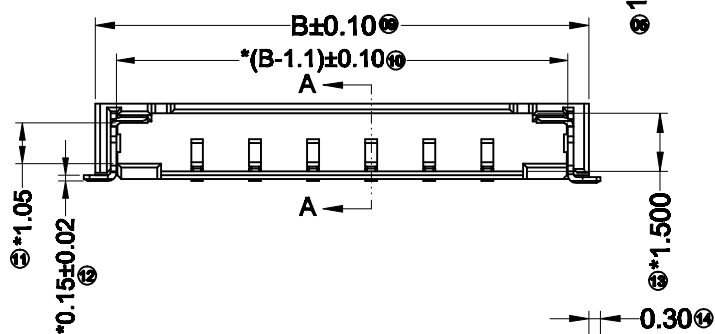

Poles	Dimensions(mm)			
	A	B	C	D
02	1.50	6.75	2.85	
03	3.00	8.25	4.35	
04	4.50	9.75	5.85	
05	6.00	11.25	7.35	3.00
06	7.50	12.75	8.85	3.00
07	9.00	14.25	10.35	3.00
08	10.50	15.75	11.85	3.00
09	12.00	17.25	13.35	6.00
10	13.50	18.75	14.85	8.55
11	15.00	20.25	16.35	10.50
12	16.50	21.75	17.85	12.00

此面不能有毛刺

M1503WRS-XX	PA4T UL 94V-0	Phorphos bronze	Gold-Flash	Brass	Tin	1503H
PART NO	Material	Material(Pin)	Finish(Pin)	Material (Solder Tabs)	Finish (Solder Tabs)	Mates With HLB Housing

未标注公差

X	±0.20
XX	±0.15
XXX	±0.08

东莞市翰皓精密电子有限公司

DONGGUAN HANHAO PRECISION ELECTRONIC CO.,LTD

料号:

M1503WRS-XX

名称:

1.50 mm Crimp Style Connectors

核准 审查 制作 日期

Yu wei 2017/06/05

单位 比例 供应商编号 版本
MM 1:1 A-100 A

日期	旧版本	新版本	变更编号	内容	审查	核准
1						
2						
3						
4						