

环保物料

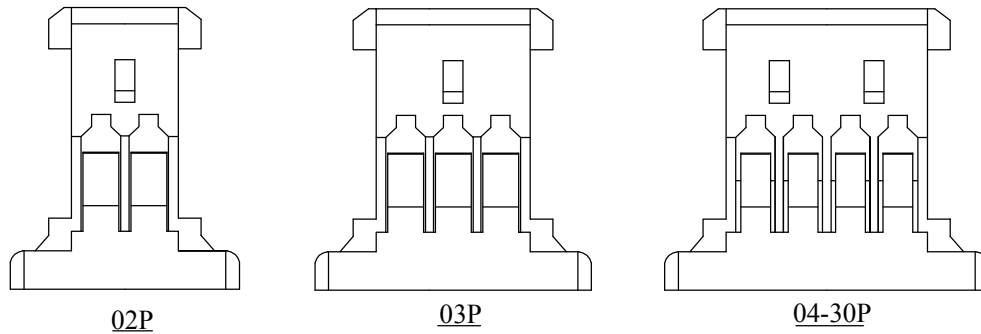
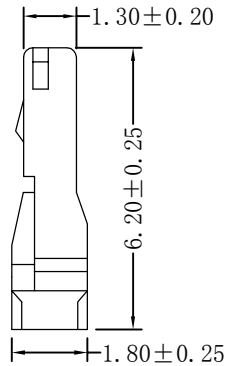
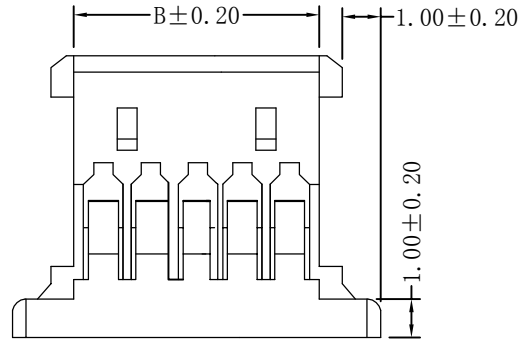
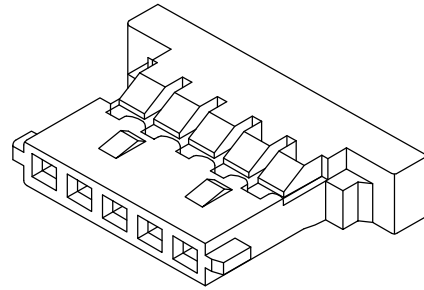
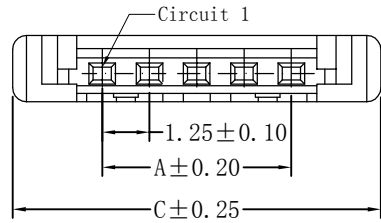

■ Specifications(规格) :

- Voltage rating(额定电压): 125V AC / DC
- Current rating(额定电流): 1A AC / DC
- Withstanding voltage(耐压值): 500V AC/minute
- Temperature range(工作温度): -25°C~+85°C
- Insulation resistance(绝缘电阻): ≥100MΩ
- Contact resistance(接触电阻): ≤20mΩ
- After environmental testing(环境测试后): ≤30mΩ

■ Housing(胶壳)

- Part No. (料号) :M1258H-XX
- Poles (PIN数) : 2-30
- Material (材质) : Nylon 66 (尼龙66) UL 94V-0
- Suitable HLB M1258T Series Terminal(匹配M1258T系列端子)
- Mates With HLB M1258WRS Series Wafer (匹配M1258WRS系列针座)
- Q' ty (数量) : 1,000Pcs/Bag/每袋 (1, 000Pcs)

Poles	PART NO.	Dimensions (mm)		
		A	B	C
2	M1258H-02P	1.25	2.72	5.72
3	M1258H-03P	2.50	3.97	6.97
4	M1258H-04P	3.75	5.22	8.22
5	M1258H-05P	5.00	6.47	9.47
6	M1258H-06P	6.25	7.72	10.72
7	M1258H-07P	7.50	8.97	11.97
8	M1258H-08P	8.75	10.22	13.22
9	M1258H-09P	10.00	11.47	14.47
10	M1258H-10P	11.25	12.72	15.72
11	M1258H-11P	12.50	13.97	16.97
12	M1258H-12P	13.75	15.22	18.22
14	M1258H-14P	16.25	17.72	20.72
15	M1258H-15P	17.50	18.97	21.97
20	M1258H-20P	23.75	25.22	28.22
30	M1258H-30P	36.25	37.72	40.72

一般公差  
GENERAL TOLERANCE  
.X ±0.3  
.XX ±0.2  
.XXX ±0.1

东莞市翰皓精密电子有限公司  
Dongguan HanHao Precision Electronics Co.,Ltd

料号 PART NO  
M1258H-XX

品名 TITLE  
1.25 mm Crimp Style connectors

2011/05/14	A	B	修改图框格式
日期 DATE	旧版次 OLD REV	新版次 NEW REV	变更内容 DESCRIPTION

审核 CHK  
核准 APPD

角法 PROJECT

核准 APPD	审核 CHK	绘图 DR	日期 DATA
DONGKUN	SUCCESS	刘艳	2007/05/03

单位 UNIT	比例 SCALE	图号 NUMBER	版次 REV
MM	1/1	A-107	B

环保物料

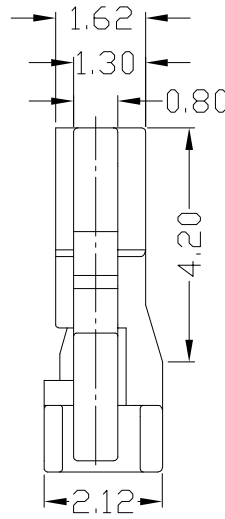
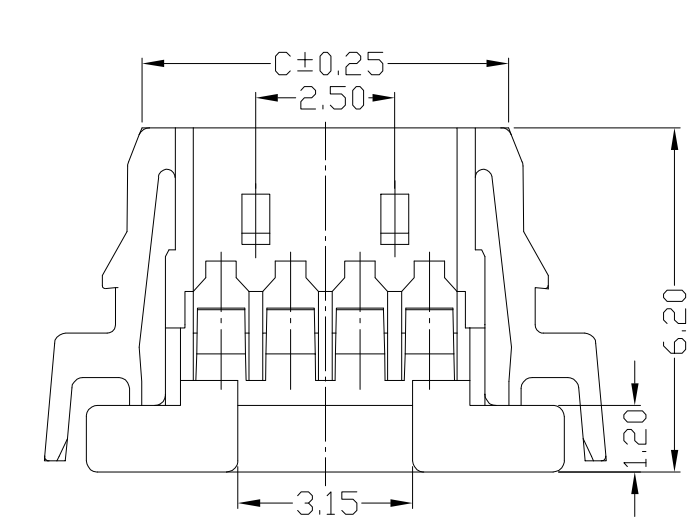
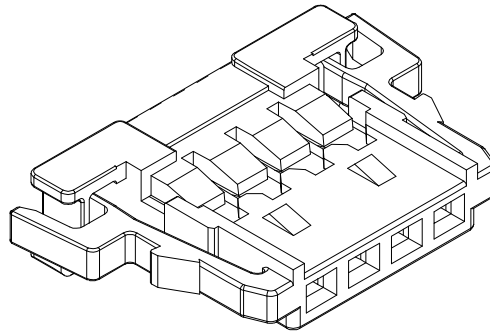
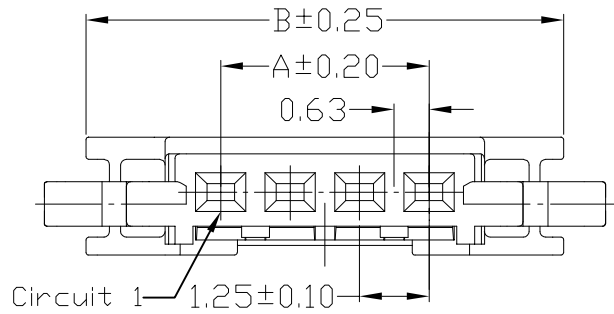

■ Specifications(规格) :

- Voltage rating(额定电压) : 125V AC / DC
- Current rating(额定电流) : 1A AC / DC
- Withstanding voltage(耐压值) : 500V AC/minute
- Temperature range(工作温度) : -25°C~+85°C
- Insulation resistance(绝缘电阻) : ≥100MΩ
- Contact resistance(接触电阻) : ≤20mΩ
- After environmental testing(环境测试后) : ≤30mΩ

■ Housing(胶壳)

- Part No. (料号) : M1258HA-XX
- Poles (PIN数) : 2-30
- Material (材质) : NOL66 UL 94V-0
- Q' ty (数量) : 1,000Pcs/Bag/每袋 (1,000Pcs)

Poles	PART NO.	Dimensions (mm)		
		A	B	C
2	M1258HA-02P	1.25	6.10	4.10
3	M1258HA-03P	2.50	7.35	5.35
4	M1258HA-04P	3.75	8.60	6.60
5	M1258HA-05P	5.00	9.85	7.85
6	M1258HA-06P	6.25	11.10	9.10
7	M1258HA-07P	7.50	12.35	10.35
8	M1258HA-08P	8.75	13.60	11.60
9	M1258HA-09P	10.00	14.85	12.85
10	M1258HA-10P	11.25	16.10	14.10
11	M1258HA-11P	12.50	17.35	15.35
12	M1258HA-12P	13.75	18.60	16.60
14	M1258HA-14P	16.25	19.85	17.85
15	M1258HA-15P	17.50	21.10	19.10
20	M1258HA-20P	23.75	27.35	25.35
30	M1258HA-30P	36.25	39.85	37.85

一般公差  
GENERAL TOLERANCE  
.X ±0.3  
.XX ±0.2  
.XXX ±0.1

东莞市翰皓精密电子有限公司

Dongguan HanHao Precision Electronics Co.,Ltd

料号 PART NO  
M1258HA-XX

品名 TITLE  
1.25 mm Crimp Style connectors

日期 DATE	旧版次 OLD REV	新版次 NEW REV	变更内容 DESCRIPTION	审核 CHK	核准 APPD	角法 PROJECT	DO	SUCCESS	刘艳	2011/05/11	单位 UNIT MM	比例 SCALE 1/1	图号 NUMBER A-106	版次 REV A
---------	-------------	-------------	------------------	--------	---------	------------	----	---------	----	------------	---------------	-----------------	--------------------	-------------



环保物料

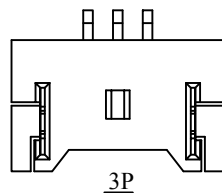
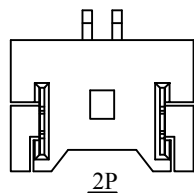
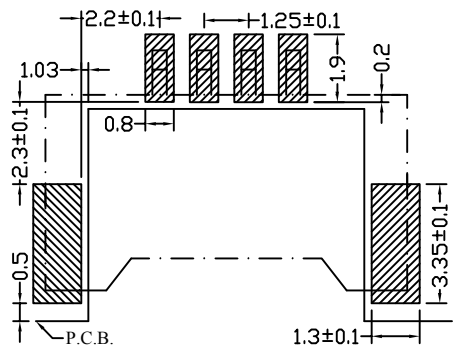
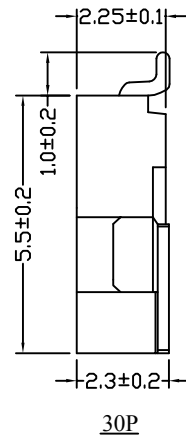
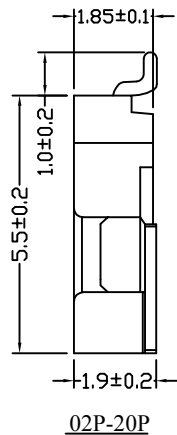
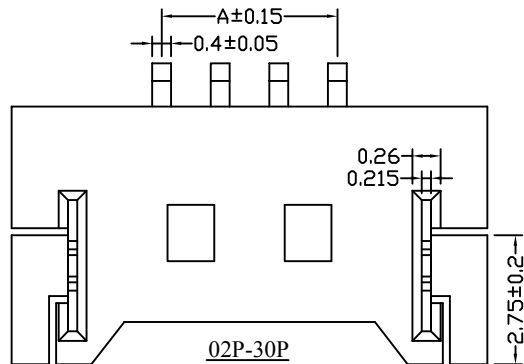
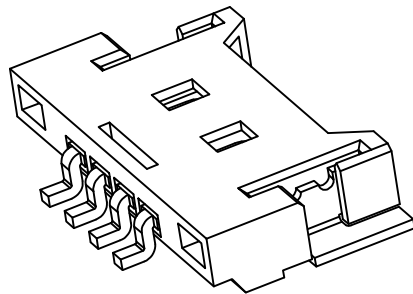
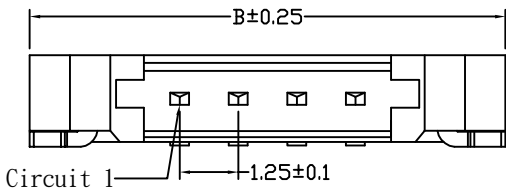

■ Specifications(规格) :

- Voltage rating(额定电压): 125V AC / DC
- Current rating(额定电流): 1A AC / DC
- Withstanding voltage(耐压值): 500V AC/minute
- Temperature range(工作温度): -25°C~+85°C
- Insulation resistance(绝缘电阻): ≥100MΩ
- Contact resistance(接触电阻): ≤20mΩ
- After environmental testing(环境测试后): ≤30mΩ

■ Wafer(针座)

- Part No. (料号) : M1258WRS-XXP
- Poles(PIN数) : 02-30
- Material (材质) : Housing(胶壳): Nylon 6T (尼龙6T) UL 94V-0
- Pin针: Brass (黄铜)
- Finish(电镀): Tin-Plated On Solder Area (焊锡区域镀锡)
- Gold-Flash On Contact Area (接触区域镀金)
- Solder Tabs(定位片): Brass (黄铜)
- Finish(电镀): Tin-Plated (镀锡)
- Mates With HLB M1258H Series Housing(匹配M1258H系列胶壳)
- Q'ty (数量) : 1,000Pcs/Bag/每袋 (1,000Pcs)

Poles	Part No	Dimensions (mm)	
		A	B
2	M1258WRS-02P	1.25	7.65
3	M1258WRS-03P	2.50	8.90
4	M1258WRS-04P	3.75	10.15
5	M1258WRS-05P	5.00	11.40
6	M1258WRS-06P	6.25	12.65
7	M1258WRS-07P	7.50	13.90
8	M1258WRS-08P	8.75	15.15
9	M1258WRS-09P	10.00	16.40
10	M1258WRS-10P	11.25	17.65
11	M1258WRS-11P	12.50	18.90
12	M1258WRS-12P	13.75	20.15
14	M1258WRS-13P	16.25	22.65
15	M1258WRS-14P	17.50	23.90
20	M1258WRS-15P	23.75	30.15
30	M1258WRS-16P	36.25	42.65

							一般公差 GENERAL TOLERANCE .X ±0.3 .XX ±0.2 .XXX ±0.1				东莞市翰皓精密电子有限公司 Dongguan HanHao Precision Electronics Co.,Ltd				料号 PART NO M1258WRS-XXP			
											品名 TITLE 1.25 mm Crimp Style connectors							
2011/05/14		A	B	修改图框格式			核准 APPD	审核 CHK	绘图 DR	日期 DATA			单位 UNIT	比例 SCALE	图号 NUMBER	版次 REV		
日期 DATE		旧版次 OLD REV	新版次 NEW REV	变更内容 DESCRIPTION			审核 CHK	核准 APPD	角法	PROJECT	LIYIZU	SUCCESS	刘艳	2007/05/03	MM	1/1	A-106	B