

环保物料

■ Specifications :

- Voltage rating: 250V AC / DC
- Current rating: 4A AC / DC
- Withstanding voltage: 100V AC/minute
- Temperature range: -40°C~+105°C
- Insulation resistance: ≥100MΩ
- Contact resistance: ≤20mΩ
- After environmental testing: ≤40mΩ
- Suitable HLB Terminal 1502T
- Mates With HLB Wafer 1502W

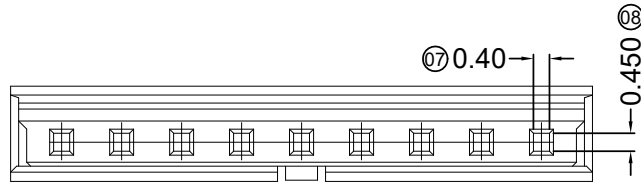
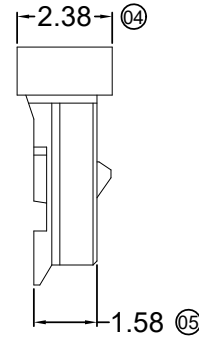
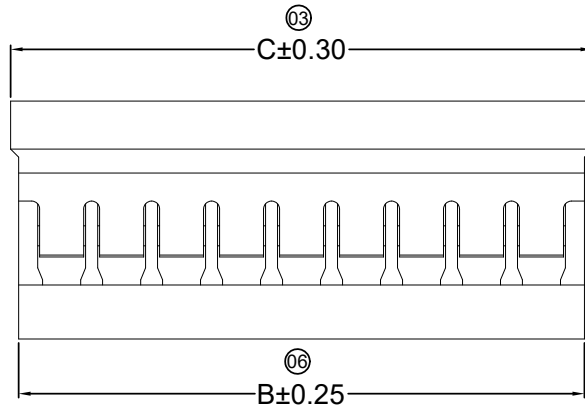
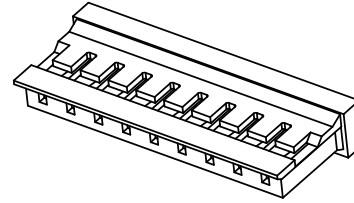
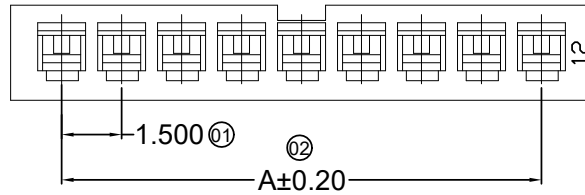

Poles	Dimensions (mm)			Poles	Dimensions (mm)		
	A	B	C		A	B	C
02	1.50	3.70	4.10	09	12.00	14.20	14.60
03	3.00	5.20	5.60	10	13.50	15.70	16.10
04	4.50	6.70	7.10	11	15.00	17.20	17.60
05	6.00	8.20	8.60	12	16.50	18.70	19.10
06	7.50	9.70	10.10	13	18.00	20.20	20.60
07	9.00	11.20	11.60	14	19.50	21.70	22.10
08	10.50	12.70	13.10	15	21.00	23.20	23.60

				一般公差 GENERAL TOLERANCE				东莞市翰皓精密电子有限公司 Dongguan HanHao Precision Electronics Co.,Ltd				料号 PART NO M1502HA-XX			
				.X ±0.3 .XX ±0.2 .XXX ±0.1				核准 APPD 审核 CHK 绘图 DR 日期 DATA				品名 TITLE 1.50mm Crimp Style Connectors			
2011/05/14	A	B	修改图框格式				SUCCESS 刘艳 2007/05/03				单位 UNIT MM	比例 SCALE 1/1	图号 NUMBER A-069	版次 REV B	
日期 DATE	旧版次 OLD REV	新版次 NEW REV	变更内容 DESCRIPTION		审核 CHK	核准 APPD	角法 PROJECT								

环保物料

- Specifications :
- Voltage rating: 250V AC / DC
  - Current rating: 4A AC / DC
  - Withstanding voltage: 100V AC/minute
  - Temperature range: -40°C~+105°C
  - Insulation resistance: ≥100MΩ
  - Contact resistance: ≤20mΩ
  - After environmental testing: ≤40mΩ
  - Wire Range AWG#26-30 Insulation O.D.1.00mm Max
  - Used In HLB Housing 1502H

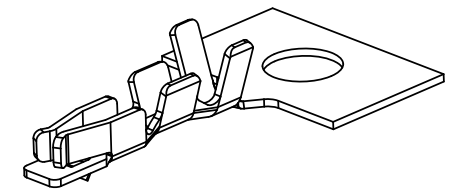
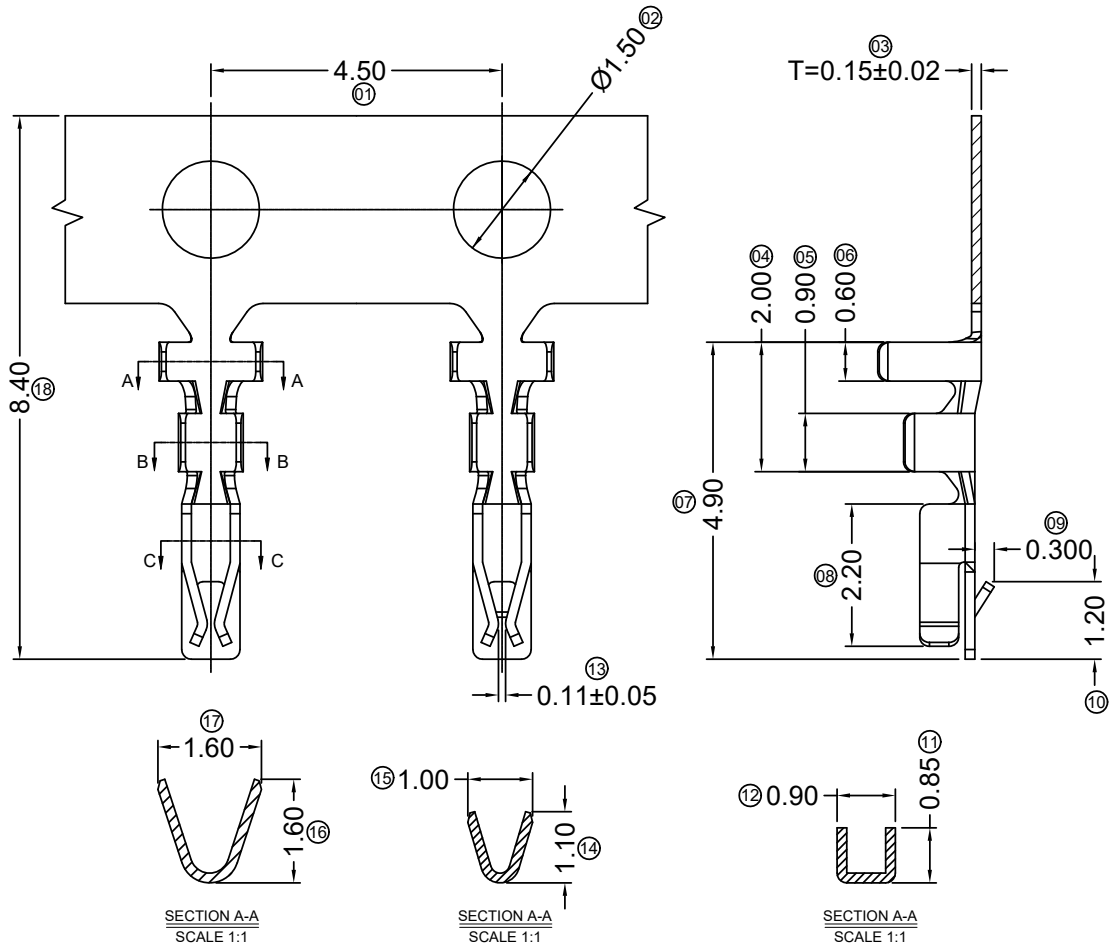

				一般公差 GENERAL TOLERANCE				料号 PART NO M1502T			
				.X ±0.3				品名 TITLE 1.50mm Crimp Style Connectors			
				.XX ±0.2				核准 APPD 审核 CHK 绘图 DR 日期 DATA			
				.XXX ±0.1				SUCCESS 刘艳 2007/05/03			
2011/05/14	A	B	修改图框格式	审核 CHK	核准 APPD	角法 PROJECT	单位 UNIT MM	比例 SCALE 1/1	图号 NUMBER A-069	版次 REV B	
日期 DATE	旧版次 OLD REV	新版次 NEW REV	变更内容 DESCRIPTION								

东莞市翰皓精密电子有限公司  
Dongguan HanHao Precision Electronics Co.,Ltd